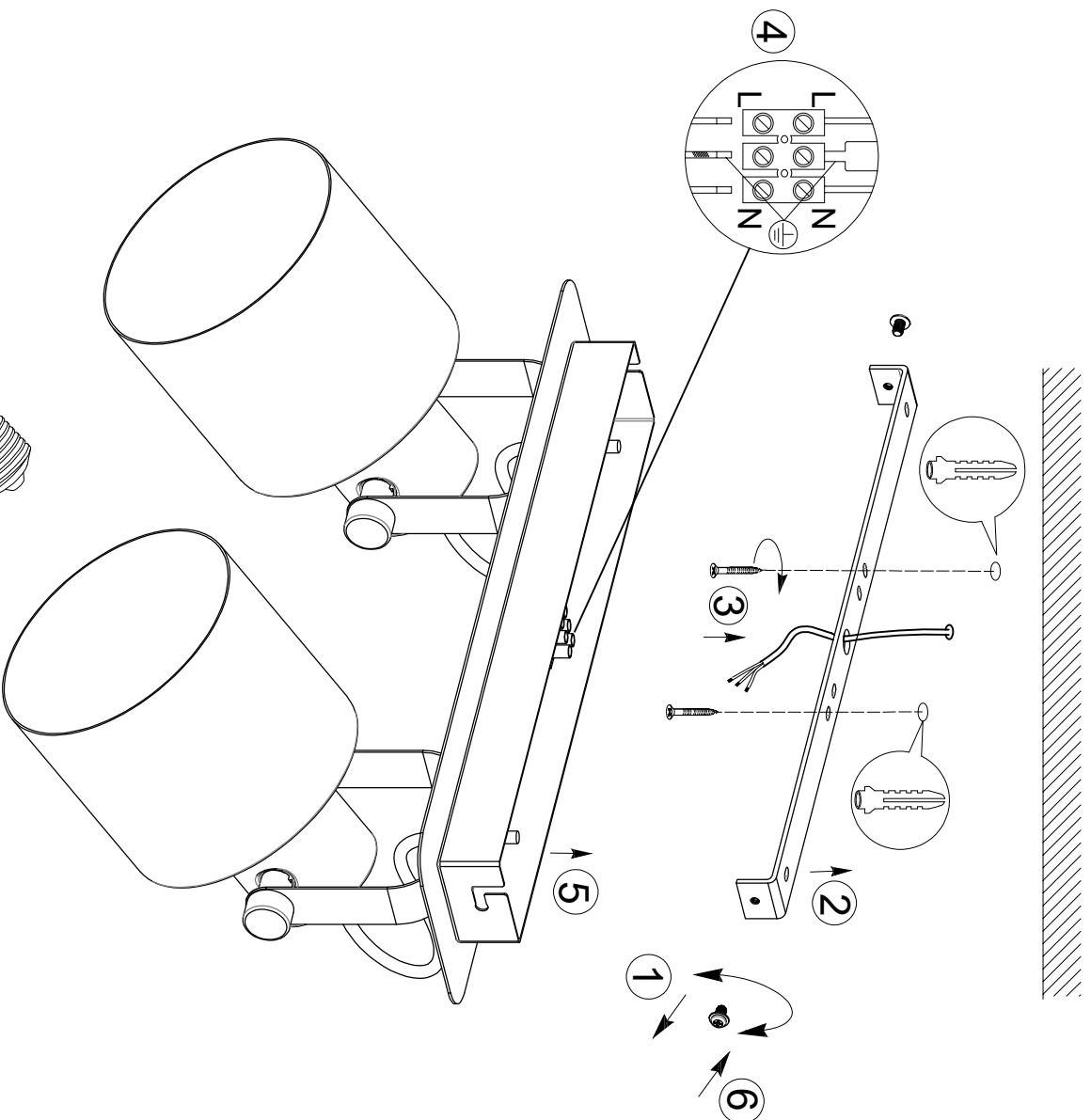
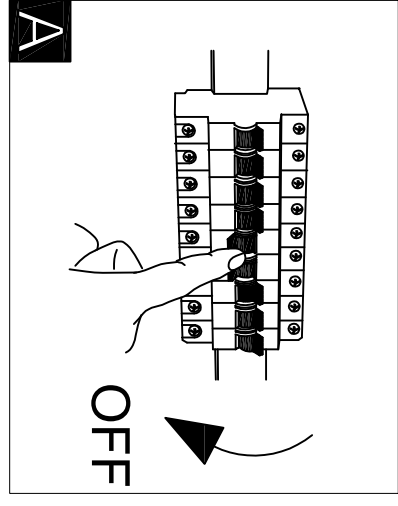
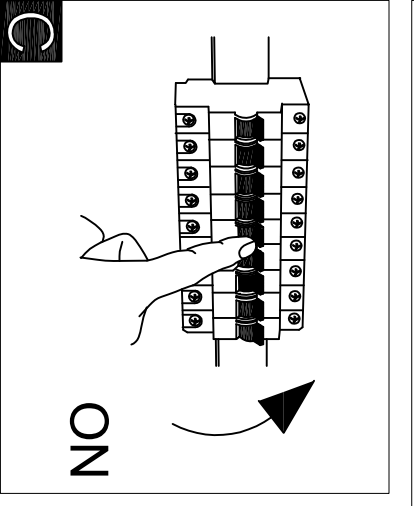

B**A****C**

B43818
www.eglo.com